



TECHNICAL REFERENCE GUIDE

Models:

Ace Force 12

Ace Firestorm 1Z490X

Ace LogiCAD 497A



TABLE OF CONTENTS

DISCLOSURES.....	3
INTRODUCTION	4
ENERGY STAR AND POWER MANAGEMENT.....	5
ILLUSTRATED SYSTEM DISASSEMBLY/REASSEMBLY INSTRUCTIONS	7
TROUBLESHOOTING YOUR PC.....	32
MAINTENANCE	34
SOFTWARE UPDATES.....	35
REMOVAL OF PERSONAL DATA	36
UPGRADES, SERVICE, AND REPAIR	39
PRODUCT TAKE BACK, END OF LIFE PROCESSING, and E-WASTE PROGRAM.....	41
REVISION HISTORY.....	42

DISCLOSURES

The information in this User's Manual has been carefully reviewed and is believed to be accurate. The vendor assumes no responsibility for any inaccuracies that may be contained in this document and makes no commitment to update or to keep current the information in this manual, or to notify any person or organization of the updates. Please Note: For the most up-to-date version of this manual, please see our website at www.acecomputers.com.

Ace Computers reserves the right to make changes to the product described in this manual at any time and without notice. This product, including software and documentation, is the property of Ace Computers and/ or its licensors, and is supplied only under a license. Any use or reproduction of this product is not allowed, except as expressly permitted by the terms of said license.

IN NO EVENT WILL Ace Computers BE LIABLE FOR DIRECT, INDIRECT, SPECIAL, INCIDENTAL, SPECULATIVE OR CONSEQUENTIAL DAMAGES ARISING FROM THE USE OR INABILITY TO USE THIS PRODUCT OR DOCUMENTATION, EVEN IF ADVISED OF THE POSSIBILITY OF SUCH DAMAGES. IN PARTICULAR, SUPER MICRO COMPUTER, INC. SHALL NOT HAVE LIABILITY FOR ANY HARDWARE, SOFTWARE, OR DATA STORED OR USED WITH THE PRODUCT, INCLUDING THE COSTS OF REPAIRING, REPLACING, INTEGRATING, INSTALLING OR RECOVERING SUCH HARDWARE, SOFTWARE, OR DATA.

Any disputes arising between manufacturer and customer shall be governed by the laws of Cook County in the State of Illinois, USA. The State of Illinois, County of Cook shall be the exclusive venue for the resolution of any such disputes. Ace Computer's total liability for all claims will not exceed the price paid for the hardware product.

The products sold by Ace Computers are not intended for and will not be used in life support systems, medical equipment, nuclear facilities or systems, aircraft, aircraft devices, aircraft/emergency communication devices or other critical systems whose failure to perform be reasonably expected to result in significant injury or loss of life or catastrophic property damage. Accordingly, Ace Computers disclaims any and all liability, and should buyer use or sell such products for use in such ultra-hazardous applications, it does so entirely at its own risk. Furthermore, buyer agrees to fully indemnify, defend and hold Ace Computers harmless for and against any and all claims, demands, actions, litigation, and proceedings of any kind arising out of or related to such ultra-hazardous use or sale.

Unless you request and receive written permission from Ace Computers, you may not copy any part of this document. Information in this document is subject to change without notice. Other products and companies referred to herein are trademarks or registered trademarks of their respective companies or mark holders.

Printed in the United States of America.

INTRODUCTION

Audience

This manual is mainly written for professional system integrators, PC technicians, and end of life recycling facilities, with the exception of the Energy Management Section, which is written to provide additional guidance on standard energy settings and configurable energy settings for the end user.

Resources

If you have any questions regarding this manual or computer system, please contact our support team through Ace Computers Support page at support.acecomputers.com

This manual may be periodically updated without notice. Please check the Ace Computers website for possible updates to the manual revision level.



ENERGY STAR AND POWER MANAGEMENT

What is Energy Star?

Created by the Environmental Protection Agency (EPA) and the United States Department of Energy (DOE), the Energy Star program is a strict set of specifications that residential appliances and construction elements (washers, dryers, refrigerators, freezers, dishwashers, televisions, tablets, computers, monitors, water heaters, HVAC units, dehumidifiers, air cleaners and purifiers, lighting, insulation and more) must meet through evaluation and testing to achieve certification.

The Energy Star rating assures consumers that the product has been EPA and DOE certified to function as well or better than its peers, while saving money, energy and the environment due to its greater energy efficiency.

Benefits of Energy Star

- Increased Efficiency
- Reduced Energy Use
- Reduced Utility Bills
- Reduced Power Plant Emissions and Carbon Footprint
- Wide Selection, Rebates, and Convenience

FORCE 12 Power Management Settings “As Shipped”

The default Power Management settings have been selected for compliance with Energy Star and are recommended by the Energy Star program for optimal energy savings.

Power Management Option	Setting
System Sleep Mode	After 30 min. of user inactivity
Display Sleep Mode	After 10 min. of user inactivity
Primary Hard Drive – “Hard Disk Turn Off”	20 min.

How to wake your computers or monitor from Sleep or Hibernate Mode?

To wake up your computer or monitor from sleep or hibernate, move the mouse or press any key on the keyboard. If this does not work, press the power button to wake up the computer.

Wake Management

- Capable of both remote (via network) and scheduled (via real time clock) wake events from Sleep Mode.
- Provide clients with the ability to centrally manage (via vendor tools) any wake management settings that are configured through hardware settings if the manufacturer has control over such features.

WoL (Wake on LAN)

WoL Capabilities/Default Settings	Yes	No
Has the ability to Enable and Disable WoL for Sleep Mode	<input checked="" type="checkbox"/>	
WoL Enables from Sleep by default:		<input checked="" type="checkbox"/>
WoL Enabled from Off by default:		<input checked="" type="checkbox"/>

WoL from Sleep:

WoL from Sleep - Default Settings	Yes	No
Shipped Enabled Under All Conditions		<input checked="" type="checkbox"/>
Shipped Enabled When Operating on AC power only		<input checked="" type="checkbox"/>
Shipped Disabled	<input checked="" type="checkbox"/>	
Shipped Disabled with both client OS and Network Controls to Enable Feature		<input checked="" type="checkbox"/>

ILLUSTRATED SYSTEM DISASSEMBLY/REASSEMBLY INSTRUCTIONS

Introduction

This section of the technical reference guide is intended to provide the following information:

- Information on parts requiring selective treatment per WEEE Directive
- Disassembly process for removal of external enclosure without tools
- Disassembly instructions, including required tools, as applicable
- Diagram and/or pictorial representation of all parts in the system

This section of the user manual is intended to provide guidance to end of life recyclers on the presence of materials and components that require selective treatment, per Article 15 of the EU WEEE Directive 2012/19/EU.

The provided information should also help direct recyclers to proper methods for removing parts and general product disassembly instructions. This Chapter also outlines specific substances, mixtures, and components that must be removed from any separately collected electronic waste component and shall be disposed or recovered in compliance with Directive 2008/98/EC.

Please note: All the illustrations in the below disassembly instructions are for demonstration only. The system and components shown in this section are a representative sample.

Replacement Parts

Refer to section “UPGRADES, SERVICE, AND REPAIR” for information on how to obtain replacement components for your system.



NOTE: While the components of this computer can be replaced by the end user, Ace Computers does not recommend that an end user without previous computer repair experience perform the upgrades and/or replacement of said components. Computer components are delicate and can easily be damaged. If you are uncertain about replacement or upgrade of your computers, the Ace Computers technical support team does offer “depot” services for on-site system repair and upgrade. Please contact the Ace Computers Technical Support team for additional information and pricing.



CAUTION: Always power off the system and unplug the power cord(s) before opening the side panel to access the internal components.



ATTENTION: Electrostatic discharge potential.

Your computer’s internal components are highly susceptible to risk of damage from electrostatic discharge (static electricity, which occurs naturally on your body due to friction). To avoid damaging your equipment, always earth yourself to your computer system before opening the computer’s chassis or handling any internal component(s).

Representative Desktop Component Layout

Please note the illustration below is a representative sample of the FORCE 12, Firestorm, and LogiCAD systems.



Chassis Cover Removal

Location: In order to access the internal components of your system, you will need to remove the left cover of the chassis.

Type and number of fastenings: Two thumb screws

Tools required: None, thumb screws are intended to be unfastened with your thumb and forefinger.

Procedure:

Step 1: Ensure the desktop is off, unplugged, and any potential energy is dissipated.

Step 2: Unfasten the (2) thumb screws on the left side rear, top and bottom, at the rear of the chassis.

Step 3: Once removed, slide the chassis side panel parallel to the chassis towards the rear, this will disengage the various tabs that are holding the panel to the chassis.

Step 4: This is the same process for the opposite side panel

Reinstallation

Step 5: To reinstall the panels lay them against the side of the case and gently slide them along the perforations ensuring the tabs catch in the proper channels.

Step 6: Reinsert the thumb screws and tighten until firm.

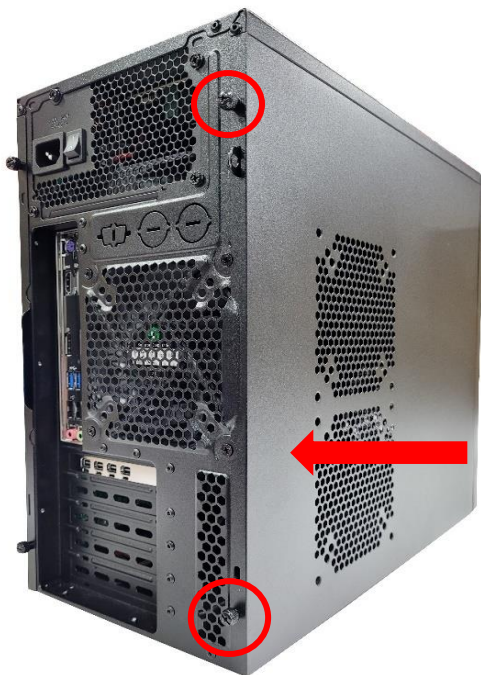

Disposal:



Selective Treatment/Special Handling Per Annex VII, Directive 2012/19/EU: None

Data Storage Devices

Location: The FORCE 12, Firestorm, and LogiCAD desktop series have the option to utilize both spinning hard drives (HDD) and M.2 SSD storage devices. The storage devices are located as indicated in Figure 1.

Type and number of fastenings: HDD = (4) Phillips screws, M.2 SSD = (1) Phillips screw.

Tools required:

HDD = Screwdriver with PH2 bit

M.2 SSD = Screwdriver with PH1 or smaller bit.

Procedure:

HDD = Bottom mount

Step 1: Ensure the desktop is off, unplugged, and any potential energy is dissipated.

Step 2: Remove the side panel from the chassis as indicated in the “Chassis Cover” section of this manual.

Step 3: The HDD is mounted to the bottom of the chassis. Turn the chassis on the side, the screws are located on the bottom of the chassis. While you are unfastening the screws be sure to secure the HDD so it does not fall and damage any of the components.

Step 4: Remove all data cables from the motherboard.

Reinstallation

Step 5: Reinstall new HDD in the same position as the one being removed, insert the (4) screws into the HDD through the bottom of the chassis.

Step 6: Attach data cable from HDD to MB, the recommended port is “SATA # 1”

Step 7: Attach SATA power from Power Supply to HDD.

Disposal:



Selective Treatment/Special Handling Per Annex VII, Directive 2012/19/EU: The HDD contains one printed circuit board greater than 10 sq. cm and must be removed from the device and must be disposed of, or recovered, in compliance with the requirements of Directive 2008/98/EC.

M.2 SSD

Step 1: Ensure the desktop is off, unplugged, and any potential energy is dissipated.

Step 2: Remove the side panel from the chassis as indicated in the “Chassis Cover” section of this manual.

Step 3: Identify the M.2 SSD on the motherboard, refer to Figure 1 for additional help. Remove the Philips screw using the PH1 or smaller bit screwdriver, then pull straight back in a parallel position to remove the M.2 SSD from the slot on the motherboard.

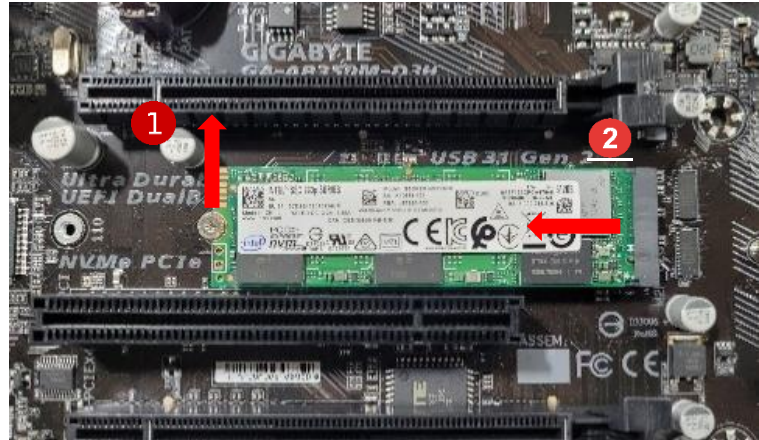

Reinstallation

Step 4: Gently slide the M2. SSD into the designated slot, as noted in the photo above, and secure with the Philips head screw using a PH1 or smaller bit.

Disposal:



Selective Treatment/Special Handling Per Annex VII, Directive 2012/19/EU: The M.2 SSD contains one printed circuit board greater than 10 sq. cm and must be removed from the device and must be disposed of, or recovered, in compliance with the requirements of Directive 2008/98/EC.

Memory

Location: The FORCE 12 model can contain up to 4 DIMMS of memory. The memory modules are found on the motherboard to the right of the heat sink fan, refer to Figure 1 for additional guidance.

Type and number of fastenings: Two (2) latches per memory module.

Tools required: None.

Procedure:

Step 1: Ensure the desktop is off, unplugged, and any potential energy is dissipated.

Step 2: Remove the side panel from the chassis as indicated in the “Chassis Cover” section of this manual.

Step 3: After locating the memory, press both release tabs on the ends of the memory module to unlock the carriage. Use gentle, even force, on either side of the memory module to remove from the memory slot.

Step 4: Repeat Step 3 for each piece of memory in the system.

Reinstallation

Step 5: Using the graphic, to install new or additional memory DIMMS, open the latch, and gently push down, with equal pressure distribution on both sides of the memory module. Ensure the memory is fully engaged, then reengage the latch to secure the memory in place.

Installing a DIMM

1



2

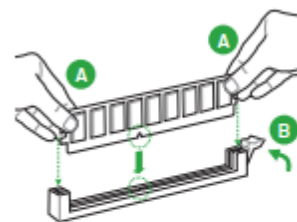

To remove a DIMM

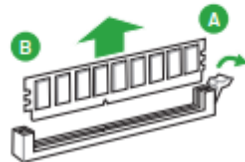

Disposal:



Selective Treatment/Special Handling Per Annex VII, Directive 2012/19/EU: The memory module is a printed circuit board of greater than 10 sq. cm and must be removed from the device and must be disposed of, or recovered, in compliance with the requirements of Directive 2008/98/EC.

Heatsink and Processor

Location: The processor is found on the motherboard underneath the heatsink fan. Refer to Figure 1 for additional guidance. The FORCE 12 motherboard only accepts a single processor.

Type and number of fastenings:

Heatsink: 4x Phillips screws

Processor: Carriage mechanism

Tools required: Phillips PH2 screwdriver

Procedure:

Heatsink with Phillips screws

Step 1: Ensure the desktop is off, unplugged, and any potential energy is dissipated.

Step 2: Remove the side panel from the chassis as indicated in the “Chassis Cover” section of this manual.

Step 3: Remove 4x Phillips screws from the base of the heatsink module. Once all 4 Phillips screws are removed you will be able to remove the heatsink module off the processor socket.

Step 4: The heatsink is powered by the motherboard, so the cable connecting the heatsink to the motherboard will also need to be disconnected. Follow the cable from the origination on the heatsink, back to the motherboard. You may have to remove the zip tie mechanisms securing the cabling along the way for successful removal.

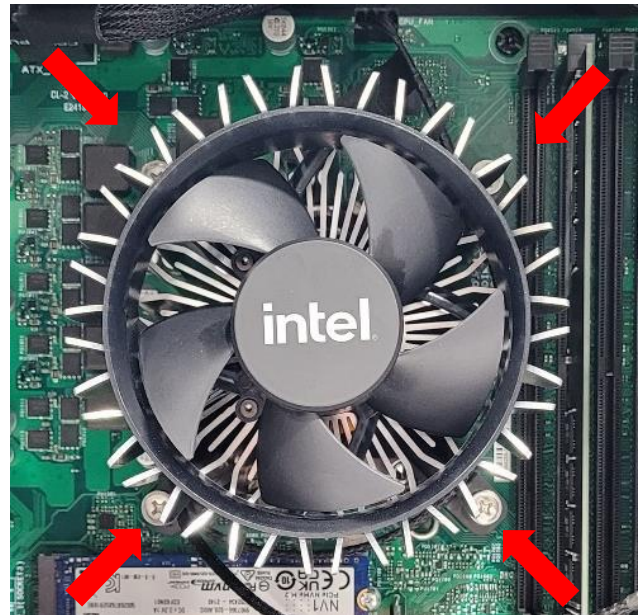

Reinstallation

Step 5: Align the heatsink with the mounting holes and reinsert the Phillips screws in the locations noted in the photo, do not over tighten the screws.

Step 6: Connect fan cable to fan header on motherboard.

Heatsink with push pin

Step 1: Ensure the desktop is off, unplugged, and any potential energy is dissipated.

Step 2: Remove the side panel from the chassis as indicated in the “Chassis Cover” section of this manual.

Step 3: Remove the fan connector from the fan header.

Step 4: Turn the push pins with a flat bladed screwdriver counterclockwise 90 degrees to release them.

Step 5: Pull up the push pins

Step 6: Remove the fan

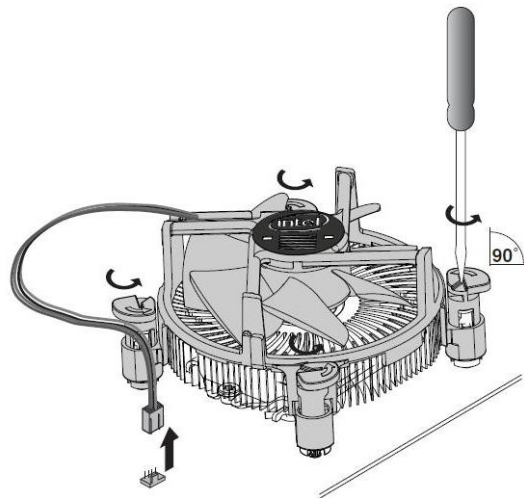

Reinstallation

Step 7: Turn the push pins clockwise 90 degrees to reset them.

Step 8: Reinsert the fan and find the push pins.

Step 9: Press the push pins in the order shown to secure them.

Step 10: Plug the fan connector from the fan header.

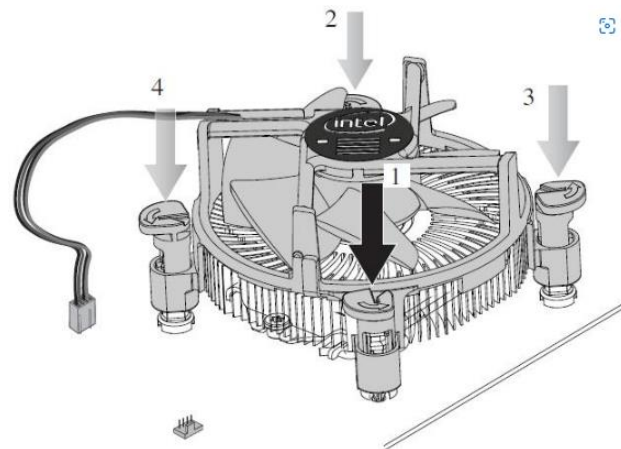

Disposal:



Selective Treatment/Special Handling Per Annex VII, Directive 2012/19/EU: Any plastic components within the heatsink fan must be removed separately due to the presence of brominated flame retardants and shall be disposed or recovered in compliance with Directive 2008/98/EC.

Processor



The removal and reinstallation of the CPU is a very delicate process and if not done with care the CPU socket could be damaged and thus leave the motherboard unusable.

Step 1: Ensure the desktop is off, unplugged, and any potential energy is dissipated.

Step 2: Remove the side panel from the chassis as indicated in the “Chassis Cover” section of this manual.

Step 3: To access the CPU, the heatsink must first be removed, refer to “heat sink” section as noted on Page 13-14 above, as applicable.

Step 4: Follow the pictorial representations indicated 1-5 below, this is the process for installation of the processor. For removal the process is the same except the CPU will already be in the socket.

Installing the CPU

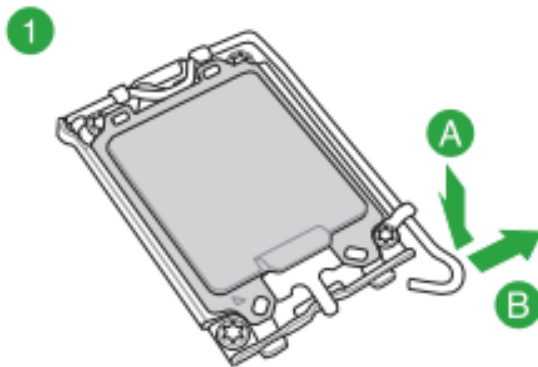
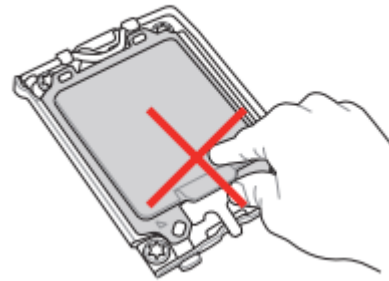

Take caution when lifting the load lever, ensure to hold onto the load lever when releasing the load lever. Letting go of the load lever immediately after releasing it may cause the load lever to spring back and cause damage to your motherboard.

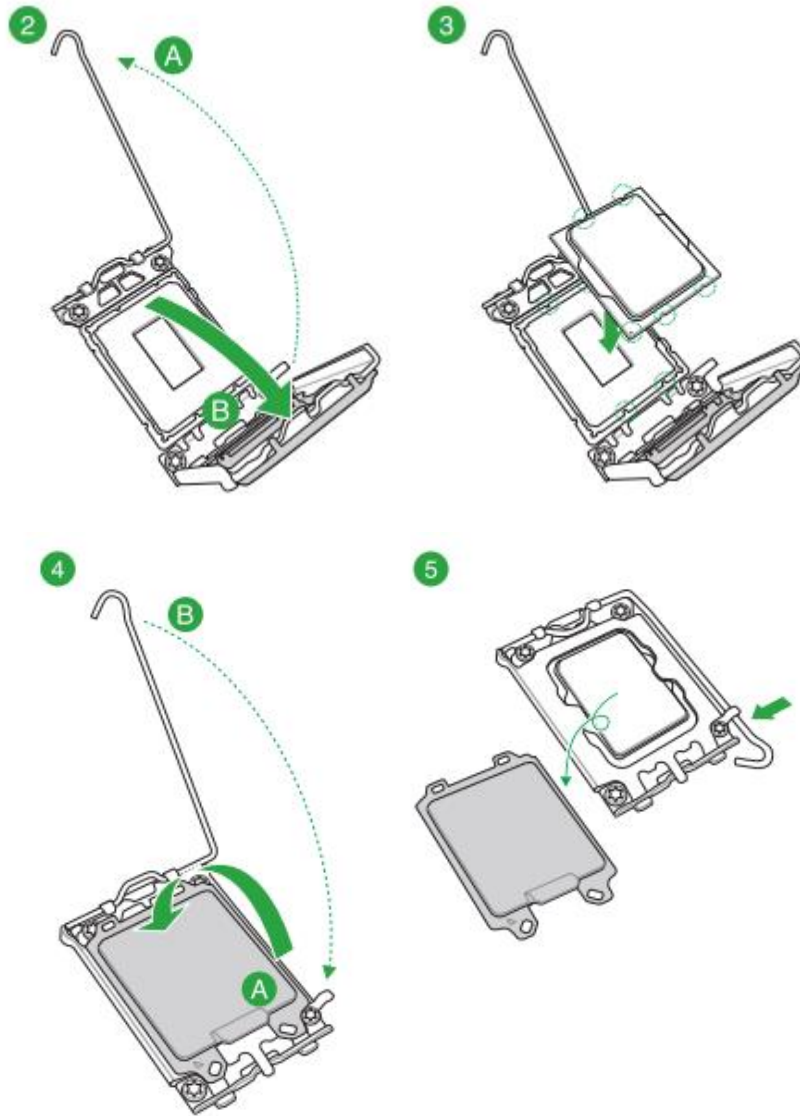

For specific details on reinstallation of the motherboard and any peripheral components of the motherboard refer to the motherboard user manual. **For re-installation of a processor specifically, ensure to utilize a thermal paste between the top of the process and the bottom of the heat sink, this allows for the best thermal heat transfer and effective cooling.**

Disposal:



Selective Treatment/Special Handling Per Annex VII, Directive 2012/19/EU: The processor must be disposed of, or recovered, in compliance with the requirements of Directive 2008/98/EC.

Expansion Cards/ Graphics Cards

Location: Certain configurations of desktops may include expansion and/or graphics cards. These can be found in the lower, left-hand corner of the system configuration. The cards are electrically connected to the motherboard via PCIe slots, and physically connected to the case.

Type and number of fastenings: One or two Phillips screws.

Tools required: Screwdriver with PH2 bit.

Procedure:

Step 1: Ensure the desktop is off, unplugged, and any potential energy is dissipated.

Step 2: Remove the side panel from the chassis as indicated in the “Chassis Cover” section of this manual.

Step 3: Remove the Phillips screws from the rear of the case.

Step 4: Disengage the retaining latch on the PCIe slot (see photo below). This is a critical step and if not done may damage the slot.

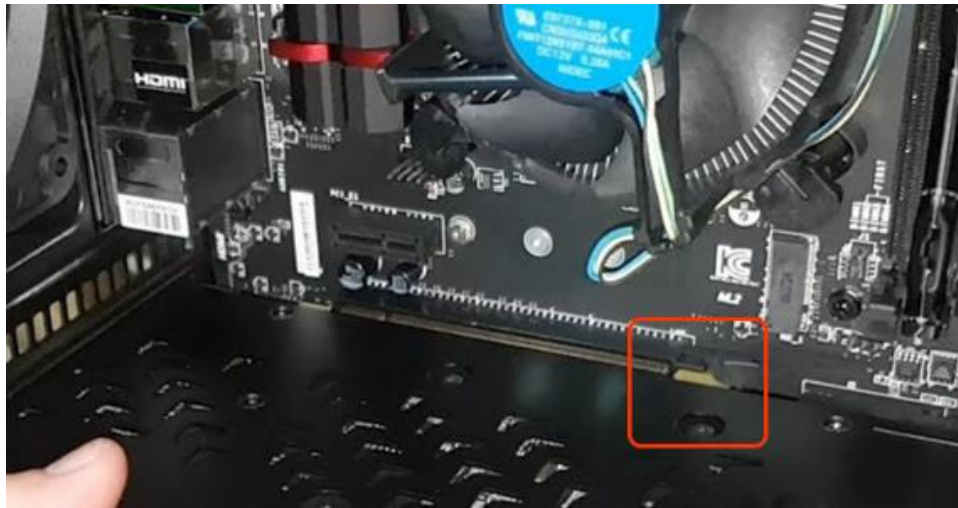

Step 5: With firm, gentle force, pull the card, perpendicular to the motherboard, out of the attaching PCIe socket. Be careful not to bend the card while still engaged in the PCIe slot.

Reinstallation

Step 6: Install the card into the PCIe 16x slot, making sure the latch “clicks”.

Step 7: Add screw to the card bracket securing the card to the chassis.



For specific details on reinstallation of the motherboard and any peripheral components of the motherboard refer to the motherboard user manual.

Disposal:



Selective Treatment/Special Handling Per Annex VII, Directive 2012/19/EU: Graphics and add on expansion cards, contain one printed circuit board greater than 10 sq. cm and must be removed from the device and must be disposed of, or recovered, in compliance with the requirements of Directive 2008/98/EC.

Power Supply Module

Location: The power supply module is located in the rear, upper portion of the chassis.

Type and number of fastenings: Four (4) Phillips Screws per module.

Tools required: Screwdriver

Procedure:

Step 1: Step 1: Ensure the computer is off, unplugged, and any potential energy is dissipated.

Step 2: Remove the side panel from the chassis as indicated in the “Chassis Cover” section of this manual.

Step 3: Remove the four exterior Phillips screws, be sure to support the power supply once the screws are removed there will no longer be anything to support the power supply.

Step 4: Remove all electrical connections from the various internal components as applicable.

Step 5: Gently slide the power supply out of the case.



When removing the connectors from the motherboard use caution, some connectors have latching clips and if not removed properly can be damaged during the removal process. See photo below for reference.

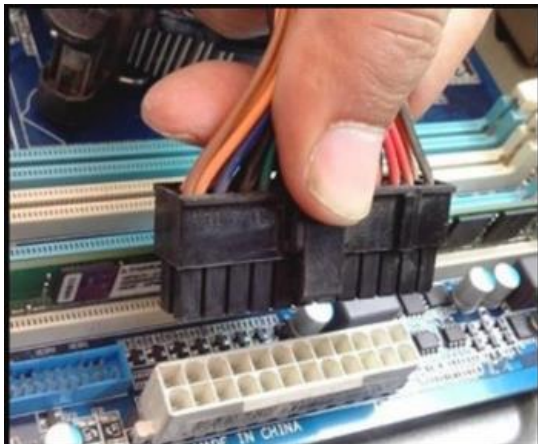

Reinstallation

Step 6: When reinstalling the power supply be sure to use care not to hit or damage other components in the system.

Step 7: Position the power supply in the upper left-hand corner of the chassis, aligning the holes of the power supply with the rear screw holes of the chassis.

Step 8: Use a PH2 Phillips screw bit, tighten the screws to secure the power supply in place.

Step 9: Reconnect the required power cables. Depending on the configuration of system this may vary, but the basic system required connection of the following:

- 24 Pin ATX_PWR (see motherboard diagram below for location)
- 8 Pin ATX_12V (see motherboard diagram below for location)
- SATA Power to HDD
- SATA Power to Optical Drive

Disposal:



Selective Treatment/ Special Handling Per Annex VII, Directive 2012/19/EU: The PSU contains a printed circuit board of greater than 10 sq. cm and must be removed from the device and must be disposed of, or recovered, in compliance with the requirements of Directive 2008/98/EC.

Motherboard



The motherboard is equipped with a lithium metal battery. The battery must be removed separately from the motherboard and shall be disposed or recovered in compliance with Directive 2008/98/EC.

Refer to the “Battery” section of this manual for additional guidance.

Location: The motherboard is generally centrally located within the unit. Standard practice would be to remove all the components, peripherals, and add-ons from the motherboard before removal of the motherboard.

Type and number of fastenings: 8 Phillips screws

Tools required: Screwdriver with PH2 bit.

Procedure:

Step 1: Ensure the computer is off, unplugged, and any potential energy is dissipated.

Step 2: Remove the side panel from the chassis as indicated in the “Chassis Cover” section of this manual.

Step 3: Remove all peripheral components on the motherboard, the details of the removal are in the applicable sections of this guide noted above.

Step 4: Disconnect all cables as necessary.

Step 5: Remove all 8 Phillips screws.

Step 6: Lift the motherboard gently from the position within the case.

Reinstallation

Step 7: Carefully slide the motherboard into the chassis be sure not to damage any soldered components on the board.

Step 8: Align the motherboard with the rear I/O shield and the motherboard standoffs located on the chassis. Be sure the motherboard is properly seated against the I/O shield and the metal prongs and not interfering with the motherboard interface ports.

Step 9: Use the same screws (8) that were removed from the uninstallation of the motherboard and replace them into the new motherboard based on the pictorial schematic noted above.

Step 10: Repopulate all peripheral components based on the various supporting sections listed in this Technical Reference Guide.



For additional details on reinstallation of the motherboard and any peripheral components of the motherboard refer to the motherboard user manual.

Disposal:



Selective Treatment/ Special Handling Per Annex VII, Directive 2012/19/EU: The motherboard is a printed circuit board of greater than 10 sq. cm and must be removed from the device and must be disposed of, or recovered, in compliance with the requirements of Directive 2008/98/EC.

Battery



Handle used batteries carefully. Do not damage the battery in any way; a damaged battery may release hazardous materials into the environment. Do not discard a used battery in the garbage or a public landfill. Please comply with the regulations set up by your local hazardous waste management agency to dispose of your used battery properly.

Location: The battery is located on the motherboard, see illustration below.

Type and number of fastenings: Interference snap fit

Tools required: None.

Procedure:

Step 1: Ensure the computer is off, unplugged, and any potential energy is dissipated.

Step 2: Remove the side panel from the chassis as indicated in the “Chassis Cover” section of this manual.

Step 3: Gently push aside the small clamp that covers the edge of the battery. When the battery is released, lift it out of the holder.

Reinstallation

Step 4: Using a new CR 2032 battery, gently push aside the clamp covers and place the battery into the holder.



Be sure to place the battery with proper directionality, the positive contact should be facing up as noted in the pictorial diagram below.

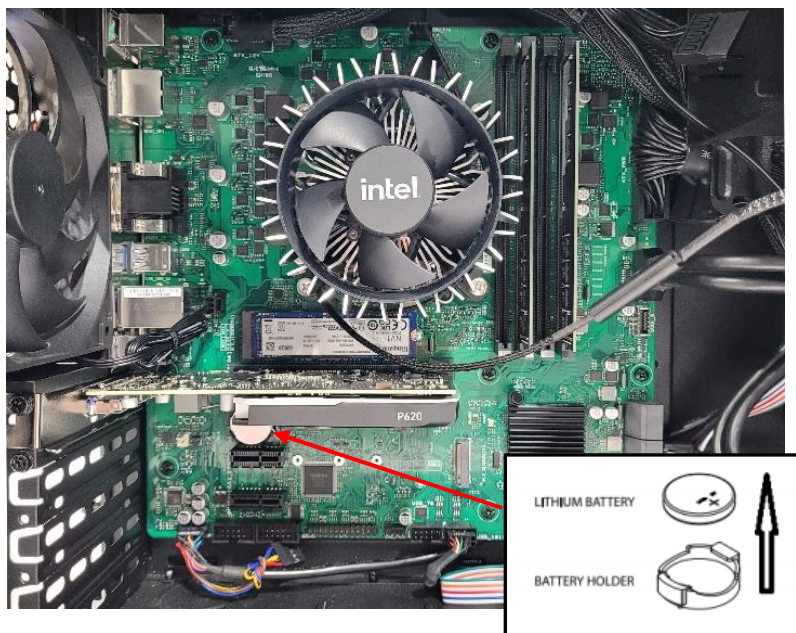

Disposal:



Selective Treatment/ Special Handling Per Annex VII, Directive 2012/19/EU: A lithium metal battery resides on the motherboard. The battery must be removed separately from the motherboard and shall be disposed or recovered in compliance with Directive 2008/98/EC.

Fans

Location: The chassis fan in the system model is located at the rear of the chassis below the power supply.

Type and number of fastenings: Four (4) Phillips Screws.

Tools required: Phillips Screwdriver.

Procedure:

Step 1: Ensure the computer is off, unplugged, and any potential energy is dissipated.

Step 2: Remove the side panel from the chassis as indicated in the “Chassis Cover” section of this manual.

Step 3: Disconnect the fan wiring from the fan header on the motherboard.

Step 4: Remove the four Phillips screws from the rear of the chassis.

Step 5: From inside the chassis gently remove the fan from the case.

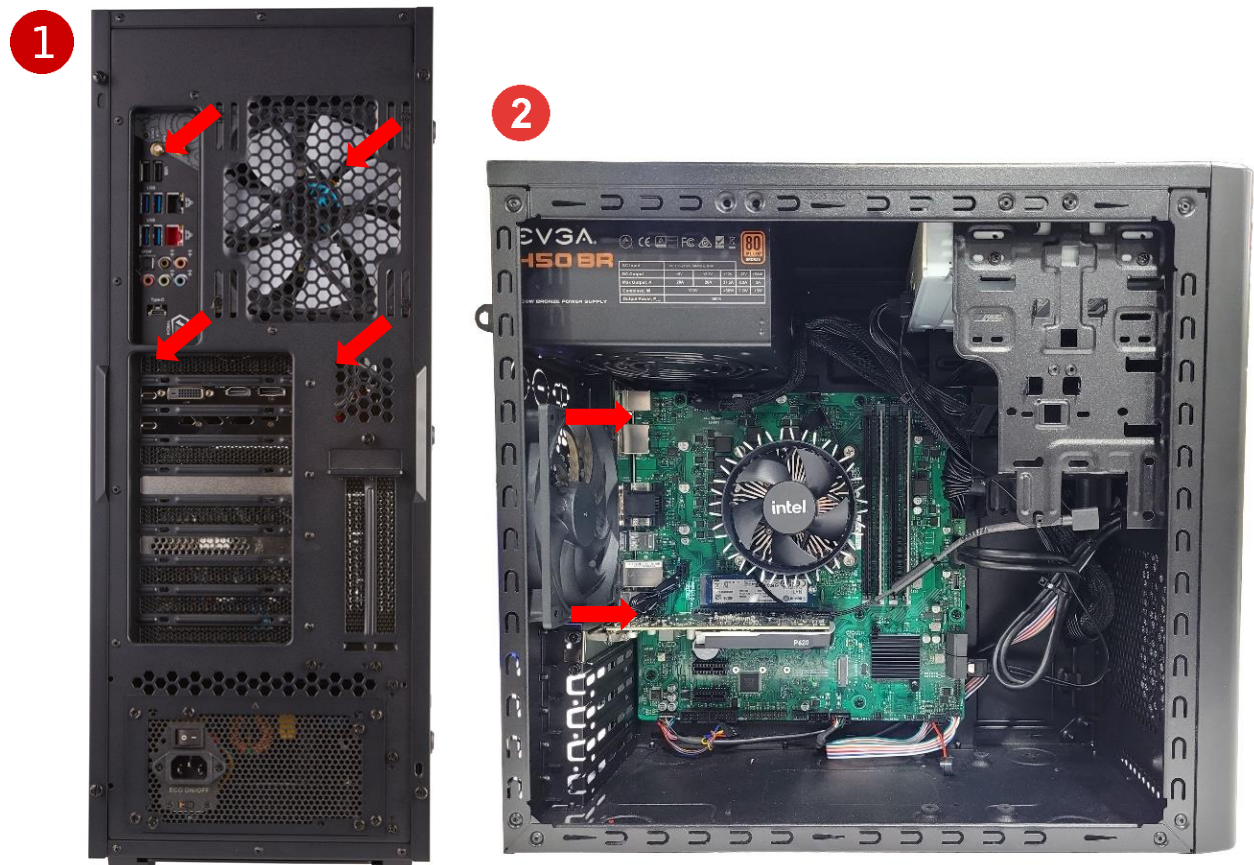

Reinstallation

Step 6: The fan is to be installed over the rear vent openings. Align your new fan over the rear vent openings, aligning the screw holes on the fan with the screw holes on the chassis.

Step 7: From the rear of the case, insert the 4 screws, in the location noted below, to secure the fan to the chassis.

Step 8: Connect the fan header cable to the motherboard for power (see motherboard user manual for reference).

Disposal:



Selective Treatment/Special Handling Per Annex VII, Directive 2012/19/EU: Any plastic components within the heatsink fan must be removed separately due to the presence of brominated flame retardants and shall be disposed or recovered in compliance with Directive 2008/98/EC.

Speaker

Location: The speaker is located on the motherboard near the bottom right-hand corner.

Type and number of fastenings: 4 pin connectors

Tools required: None



Procedure:

Step 1: Ensure the computer is off, unplugged, and any potential energy is dissipated.

Step 2: Remove the side panel from the chassis as indicated in the “Chassis Cover” section of this manual.

Step 3: Locate the speaker and gently but firmly pull away from motherboard connector.

Reinstallation

Step 4: Locating the speaker header on the motherboard, reinstall the speaker with “RED (+)” on the speaker aligning with PIN 1 of the speaker header on the MB (see photo below for reference, location is bottom right-hand corner of MB).

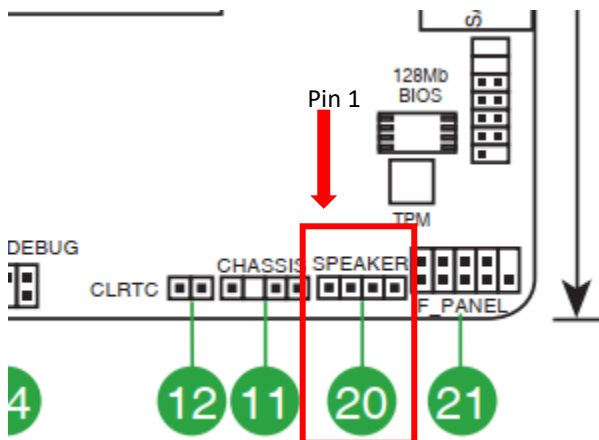

I/O Connections

Location: There are three locations on the system that have I/O connections.

- (1) The rear of the chassis (integrated into the motherboard)
- (2) The front of the chassis (these are optional add on expansion bays)
- (3) The rear of the chassis (integrated into the graphics card, as applicable)
- (4) The top of the chassis (integrated into the case)

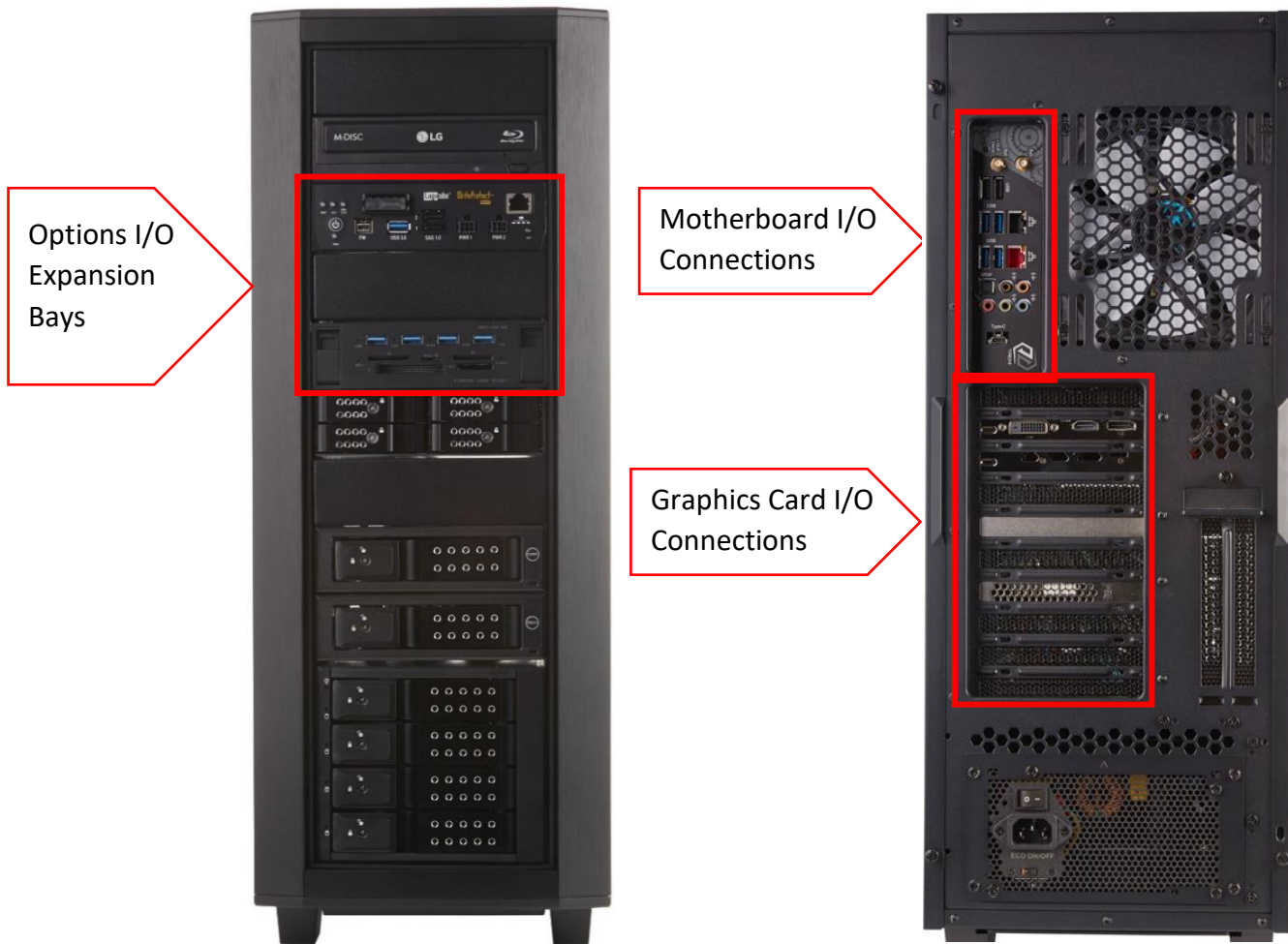

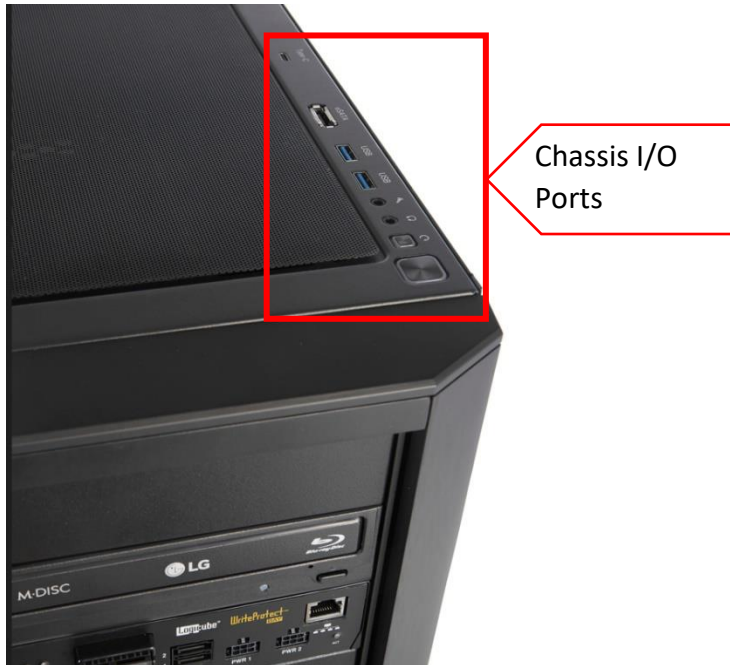

Procedure:

Note: I/O connections are integral parts of higher-level assemblies and thus to replace them the entire assembly would need to be replaced.

To uninstall/reinstall any of the I/O connections refer to the sections below:

- (1) Motherboard Section (page 21-22).
- (2) Chassis Section (page 9)
- (3) Expansion Card/Graphics Card Section (page 17-18).
- (4) Optional I/O Expansion Bays (page 27-28)

Optical Drive, I/O Expansion Bays, Hotswap HDD bays (optional)

Location: The optical drive, I/O expansion, and Hotswap HDD bays are optional add ons for this model. The optical drive, I/O expansion, and Hotswap HDD, if applicable, are located in one of the front drive bays of the chassis.

Type and number of fastenings: Four (4) Phillips Screws.

Tools required: Phillips Screwdriver.

Procedure:

Step 1: Ensure the computer is off, unplugged, and any potential energy is dissipated.

Step 2: Remove the side panel from the chassis as indicated in the “Chassis Cover” section of this manual. For removal of the optical drive, both chassis covers will need to be removed. The process is the same for both sides.

Step 3: Located along the front side of the chassis in the mounting bays, are all of the add on drive bay options, the add on options are generally mounted with (4) Phillips screws, (2) on either side of the chassis.

Step 4: Disconnect SATA power and data cables from all optional bays, as applicable.

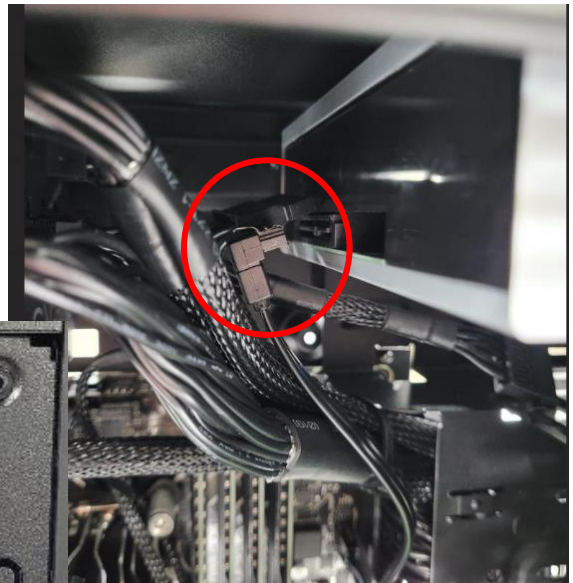
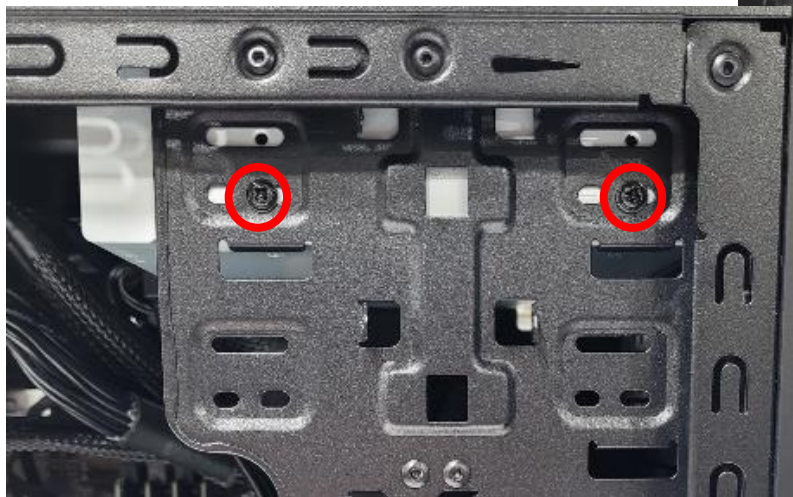

Step 5: Remove 1-2 phillips screws on the internal side of the case

Step 6: Remove 1-2 phillips screw on the opposite side of the case.



Step 7: Pull out the optional drive bay expansion component.



Reinstallation

Step 8: To reinstall all add on optional expansion drives bays, follow the uninstallation steps backwards.

Step 9: Slide optical drive into the front drive bay in the desired location.

Step 10: Insert (2) screws on the left side of the chassis (when looking from the front) and (1) screw on the right side of the chassis (when looking from the front).

Step 11: Reconnect power header (most often SATA) to expansion bay component from PSU and SATA data cable from expansion bay component to motherboard.

Disposal:



Selective Treatment/ Special Handling Per Annex VII, Directive 2012/19/EU: The optical drive and I/O expansion drives contain one printed circuit board greater than 10 sq. cm and must be removed from the device and must be disposed of, or recovered, in compliance with the requirements of Directive 2008/98/EC.

External Power Cable

Location: The inlet to the power cable is located on the externally facing portion of the power supply.

Type and number of fastenings: None, direct pressure connection method.

Tools required: None.

Procedure:

Step 1: Ensure your computer is powered down and the power supply is in the off position.

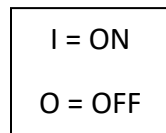

Step 2: Disconnect the external power cable from the main desktop assembly.

Reinstallation

Step 3: Connect the external power cable from the rear of the chassis into the power supply connection point.

Step 4: Turn the power supply back on.

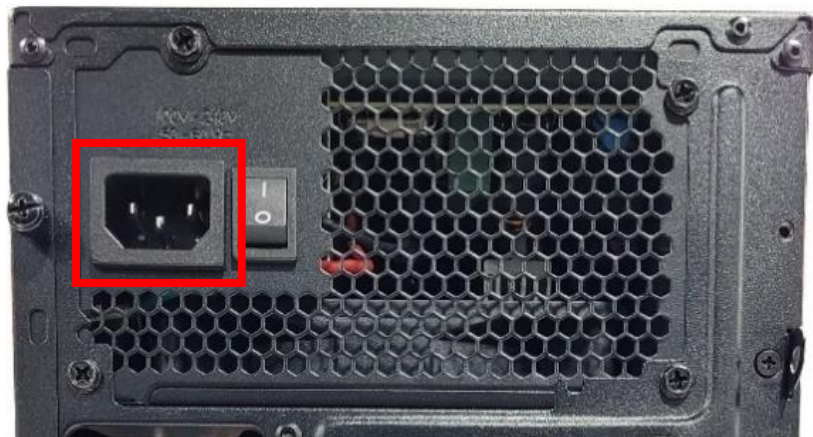
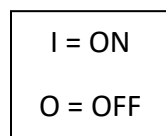

Disposal:

 Selective Treatment/Special Handling Per Annex VII, Directive 2012/19/EU: Any external electrical cables must be removed separately and shall be disposed or recovered in compliance with Directive 2008/98/EC.

TROUBLESHOOTING YOUR PC

If your computer will not power on, try the following steps:

1. Make sure the power cord is fully connected to the power supply and to the wall outlet.
2. Make sure the power supply is switched to “ON” (switch located next to the power cord on the back panel of your PC).
3. If using a surge protector, try connecting the power cord directly to a wall outlet.
4. It is possible for the internal power connectors to come loose during shipping. Carefully remove the side panel and check both the 24-Pin and CPU power connectors to make sure they are fully seated.
5. If your system still will not power on, please contact our support team.

If your computer screen is black, but your computer is turned on, try the following steps:



If your computer has a video card installed the on-board video may be disabled. Ensure you have your monitor connected to the proper rear port.

1. Check all the connection(s) on the video card and your monitor – make sure they are fully seated.
2. Select the correct source on your monitor.
3. If available, use a different display cable and see that if that resolves your issue.
4. If none of the above steps worked, please contact our support team.

If your computer will not boot into windows, try the following steps:

1. This can happen when installing new drivers, applications, or malicious software. Did you install new hardware? Did you accidentally unplug something when working inside the computer? This can be from various reasons, try these steps:
2. If you recently opened your computer to clean, install new hardware, etc. You may have accidentally unplugged power or data cables. Check all the power and data connections on your components and motherboard.
3. Enter your computer’s BIOS and check its boot order setting, ensuring that it is set to boot from the correct drive that has the operating system installed.
4. After trying the steps above and you are still unable to boot into windows, please contact our support team.

If your computer freezes or crashes during boot, try the following steps:

1. If Windows seems to boot fine but hangs halfway or blue screens and restarts, it may be a software or hardware problem. Try the following steps:
2. Attempt to boot into safe mode. If the computer is stable in safe mode, try uninstalling any recently installed hardware drivers, perform a system restore, and scan for malware. Newly installed drivers or malicious software may be causing this issue.
3. If your computer is still freezing or crashing, you may want to try the “Reset This PC” option. This will restore your computer to its factory state. You can choose to “Keep My Files” or “Remove Everything”.
4. If you are still experiencing Windows freezing or crashing during boot, it may be a hardware issue. Please contact our support team.

MAINTENANCE

Removing Dust Build Up

Dust buildup may lead to overheating and could potentially cause serious damage to your PC components. If fans get clogged with dust, they may begin to turn at a slower RPM reducing the effectiveness of the fan and leading to overheating of the PC. The issue of dust build up is applicable to all fans within the system (e.g. case fan, CPU fan, AIO radiator, GPU fans, etc.). If fans build up enough dust the motors may seize and completely fail, requiring the fan to be replaced.

Regular Maintenance Steps

- 1. Remove PC from all power sources, unplug the system from the wall and/or surge protector. It is best to let the unit set for a few minutes, pressing the on/off button a few times to dissipate any energy the capacitors may be storing.*
- 2. Compressed air is a great tool to remove dust quickly and safely. Remember to read the instructions on the use of compressed air before use.*
- 3. Remove all the large dust particle by hand and use the compressed air to blow away and smaller residual particles.*
- 4. Repeat about every 3 months or so, or as needed for areas that are more dust prone.*



Virus and Malware Protection

You should check your PC often for malware. You can do this by running a scan using Windows Defender, but for deep system scans, it is always good to use a secondary software as well – just to be safe. There are multiple reputable Anti-Malware companies; one that is commonly used is Malwarebytes. Running weekly deep system scans would be the best choice.

SOFTWARE UPDATES



Utilization of the most up to date OS software version and patches will provide the best possible defenses against viruses and malware.

Periodic Check for Software Updates

Windows will periodically look for and apply critical patches and security updates. Allows your system, during the initial setup of the system, to automatically update, this will provide the most secure user environment.

Please make sure to allow the system to apply updates within a reasonable time frame from when installed.

To access Windows Update, start by clicking on the “Start Button” and selecting the Gear Icon (Settings) on the left side of the menu.

1. Once you are in the “Windows Settings” window, click on the “Update & Security” tab.
2. You should now be at the “Windows Update” screen. You can visit this page and click on the “Check for updates” button to see if your system needs updates.
3. We highly recommend checking Windows Updates often as security is extremely important.

Periodic Update of Device Drivers

It is good practice to keep an eye out for updating device drivers. Although some components use utilities to give you a heads up when an update is ready, that is not always the case for drivers. Device drivers play a crucial role in the smooth functionality of your PC. We recommend visiting the manufacturer’s website to get the latest stable drivers.

Contact Ace Computers Support Desk for help

Ace Computers staffs a technical support desk and is always ready to help.



You can contact the team at support@acecomputers.com

- or-

call 877-223-2667

-or-

visit the acecomputers.com and click “Support” to start a new support ticket online.

REMOVAL OF PERSONAL DATA



Be sure to back up all information that you desire to keep on alternative drives before deleting data as this process cannot be reversed.

Digitally Erasing Information

Resetting your PC may be done for various reasons, but one reason may be to remove all your personal information and return the PC to the original settings.

Step 1: Select the **Start** button, then select **Setting > Update & Security > Recovery > Open Recovery Settings**.

Step 2: Under **Reset this PC**, select **Get Started** and then choose from the options and/or setting in the table below.

Option	What it Does
Keep my files > Change settings > Preinstalled apps On	<ul style="list-style-type: none">Reinstalls Windows 10/11 and keeps your personal files.Removes apps you installed.Removes changes you made to settings.Restores any apps your PC manufacturer installed.
Keep my files > Change settings > Preinstalled apps Off	<ul style="list-style-type: none">Reinstalls Windows 10/11 and keeps your personal files.Removes apps you installed.Removes changes you made to settings.Removes any apps your PC manufacturer installed.

Option	What it Does
Remove everything	<ul style="list-style-type: none"> Reinstalls Windows 10/11 and removes your personal files. Removes apps you installed. Removes changes you made to settings. Removes any apps your PC manufacturer installed.

 Remove everything > Change settings gives you two options.

Data erasure **On** removes files and cleans the drive. If you're planning to donate, recycle, or sell your PC, use this option. This might take an hour or two, but it makes it harder for other people to recover files you've removed.

Data erasure **Off** just removes files. It takes less time but is less secure.

Mechanically Destroying Storage Devices – Hard Drive



It is important to use proper personal protection equipment (eg. Safety glasses, gloves, etc.) when working with tools, power tools, or using blunt force to destroy an HDD. Use good judgment and caution!

HDD:

There are several ways to disable/destroy a hard drive mechanically/physically, but these directions will discuss how to do it with commonly available tools.

For instruction on how to remove the HDD and/or SSD refer to the “Data Storage Devices” section of this manual above.

Once the HDD is uninstalled the following can be done to physically destroy the unit so it can no longer be used.

Step 1: Unscrew the metal casing on the hard drive (the screws vary on model, but are usually Torx or flathead)

Step 2: Remove the read/write arm (the triangular magnet that extends over the metal disk)

Step 3: Scratch the disk with something sharp, breaking it into pieces if possible

Step 4: Remove/destroy the circuit board inside the drive

If a screwdriver cannot be used to access the internal components of the HDD, inflicting severe damage with a blunt object, rock, hammer, etc. will destroy the HDD beyond repair.

Additionally, using a drill press, or drill of sorts to drill through the HDD will also destroy the HDD beyond repair.

SSD:

The process for destroying an SSD is much simpler, it can simply be destroyed beyond use, there is no protective outer cover. Use of a hammer, stomping on the component, breaking in half, etc. are all simple examples of how to destroy the SSD beyond use.

Disposal:



Refer to the “Digital Storage Devices” Section of the manual above for details on how to properly dispose of HDD’s and SSD’s.

Replacement Hard drives

Refer to the section below titled “Upgrade, Service, and Repair” for information on how to replace your hard drive in the event it was required to be destroyed after removing personal information.

UPGRADES, SERVICE, AND REPAIR

The following table is a list of all included hardware features, and a few hardware features that could be added as an upgrade option.

Note: all add on hardware features do not fall within the original scope of this product and void all certifications/regulatory compliance attestations.

Replacement and Repair Services are available for a minimum of three years after date of purchase, and often times if a direct replacement is not available and upgrade replacement can be found for several years beyond the initial 3-year mark, ensuring the longest possible utilization of your PC.

Hardware Features	Upgradeable	Repairable	Replaceable
Chassis	☑	☑	☑
Motherboard (including ethernet)	☑		☑
CPU	☑		☑
CPU Heatsink	☑		☑
Power Supply	☑		☑
Case Fans	☑		☑
Memory (both type and total capacity; max memory 64GB over 4 DIM channels)	☑		☑
Storage (M.2 SSD and HDD)	☑		☑
Optical Drive, I/O Expansion Bays, and Hotswap Storage Drives	☑		☑
Graphics	☑		☑
Cabling (cabling requirements may differ from base if upgraded components are utilized)			☑
Speaker			☑
External Power Connection Cable			☑
WIFI (not included standard onboard, upgrade would require add-on network card)	☑		



For specific details on reinstallation of the motherboard and any peripheral components of the motherboard refer to the motherboard user manual.

Ordering Parts, Requesting Repair, or Talking to Technical Support

The Ace Computers technical support team is ready and available to help in providing replacement parts, helping to identify compatible upgrades, or to answer software questions.

Please have your serial number available for reference when contacting Ace Computers.

You can contact the team at support@acecomputers.com

- or -

call 877-223-2667

-or-

visit the support.acecomputers.com site online.



Spare Parts List

Component Description	Part Number
Chassis	JS889-NPS
Motherboard	XXXXXXXXYY* Motherboard
CPU	XXXXXXXXYY* CPU Spare Part
CPU Heatsink	XXXXXXXXYY* CPU Heatsink Spare Part
Power Supply	XXXXXXXXYY* PSU Spare Part
Case Fans	XXXXXXXXYY* Case Fan Spare Part
Memory	XXXXXXXXYY* Memory Spare Part
Storage (M.2 SSD and HDD)	XXXXXXXXYY* Storage Spare Part
Optical Drive	XXXXXXXXYY* Optical Drive Spare Part
Hotswap HDD Drive	XXXXXXXXYY* Hotswap HDD drive Spare Part
I/O Drive Bay	XXXXXXXXYY* I/O Drive Bay Spare Part
Graphics	XXXXXXXXYY* GPU Spare Part
Cabling	XXXXXXXXYY* Cabling Spare Part
External Power Connection Cable	XXXXXXXXYY* Power Connection Spare Part
Speaker	XXXXXXXXYY* Speaker Spare Part

*Where XXXXXXXYYY is the initial 9 characters of the computer serial number.

Spare parts can be purchased by contacting the Ace Computers Technical Support Team.

PRODUCT TAKE BACK, END OF LIFE PROCESSING, and E-WASTE PROGRAM

Nation Wide Take Back Services

If your PC has reached its end of life or is no longer useable, Ace Computers is excited to offer a Nation-Wide take back service. We will work with you to get the product back and will ensure it is proper disposed of with a certified R2 electronics recycling facility.

Ace Computers has partnered with a local R2-certified electronics waste recycling facility near our HQ in Des Plaines, IL.

For additional information and steps to take regarding our Product Take-Back, End-of-Life Processing, and E-Waste Program, please visit our website at <https://acecomputers.com/company/sustainability/> > EPEAT Take-Back/EOL/E-Waste Program Tab.

REVISION HISTORY

Release Date	Changes
9.27.2022	Initial Release
9.28.2022	Updated disposal details for PSU